

ExpoM – RF 4

User Manual

Revision 7.1 (March 7th, 2025)



ExpoM – RF 4

User Manual

Contents

1 Description	5
1.1. Principle of operation	5
2 Case and interfaces	6
2.1. Multi-color LED	6
2.2. USB interface and cable	7
3 Using ExpoM-RF 4	8
3.1. Starting a measurement	8
3.2. Setting a marker	8
4 Battery management	9
4.1. Charging the battery	9
4.2. Over-discharge protection (automatic shutdown)	9
5 ExpoM-RF 4 Utility (PC Software)	10
5.1. Connecting to an ExpoM-RF 4 device	10
5.2. Measurement data organization and download	11
5.3. Plotting Data	12
5.4. Saving the measurement data to file / data format	14
5.5. KML Export	15
5.6. Device Settings	16
5.7. Setting up PIN lock	19
5.8. Firmware Update	19
5.9. Spectrum Scan (Spectrum Analyzer Mode)	21
5.10. Installing the USB driver	23
6 Troubleshooting	24
6.1. How can I improve the battery runtime?	24
6.2. The device does not charge the battery	24
6.3. Device not recognized	24
6.4. Window Display Issues	26
7 Device Calibration Options	28
7.1. Basic calibration option	28
7.2. Extended calibration option	28

7.3.	Full calibration option	28
8	Crosstalk optimizations.....	29
9	Smartphone App.....	31
9.1.	Introduction	31
9.2.	Device Setup.....	31
9.3.	Installing the App	31
9.4.	Starting the App	31
9.5.	Connecting to a Device	32
9.6.	Live View	32
9.7.	Spectrum Scan.....	33
9.8.	ExpoM Settings	35
9.9.	Setup Guide.....	35
9.10.	Hardware Requirements.....	35
9.11.	Troubleshooting.....	35
10	Technical Specifications	36
10.1.	Frequency bands and measurement range	36
10.2.	Calibration Options	36
10.3.	RF Measurement.....	36
10.4.	Size / Conditions.....	36
10.5.	Connectivity / Storage.....	37
10.6.	Battery Management.....	37
10.7.	ExpoM-RF Utility Software	38
10.8.	ExpoM-RF Android Software.....	38

1 Description

ExpoM - RF 4 is a flexible wideband personal radio frequency exposure meter with integrated data logger and GPS localization. Band selective measurements allow for a detailed differentiation of different electromagnetic field sources. ExpoM - RF 4 performs simultaneous true-RMS and peak detection of the measured signals. The ability to configure custom band lists with arbitrary frequencies from 50 MHz to 6 GHz gives ExpoM-RF 4 an unprecedented level of flexibility and makes it inherently future-proof with respect to changes in frequency band allocations and regulations. Different sensitivity settings allow ExpoM-RF 4 to be used in situations where low minimum detection limits are required as well as in locations where high field strength are expected. Built-in Wi-Fi connectivity enables real-time transmission of measurement data to mobile devices or cloud services.

1.1. Principle of operation

ExpoM-RF 4 relies on a heterodyne architecture allowing continuous frequency coverage. A simplified block diagram of the relevant components is shown in Figure 1. The incoming signal measured by the built-in 3-Axis antenna is first coarsely filtered to prevent image responses in the frequency conversion process. After this first filtering stage, a low noise amplifier (LNA) or an attenuator stage can be switched into the signal path to extend the measurement range of the device. The subsequent frequency conversion stage translates the signal of interest to the fixed-frequency bandwidth filters (35, 75, or 100 MHz). The envelope of the filtered signal is extracted by means of an envelope detector and digitized at the rate of 1MS/s. Data is continuously sampled for the measurement duration of 50 ms per band. The peak and the RMS value of the signal are then computed by digital signal processing stage and stored to memory. This process is repeated for each band in a measurement sample.

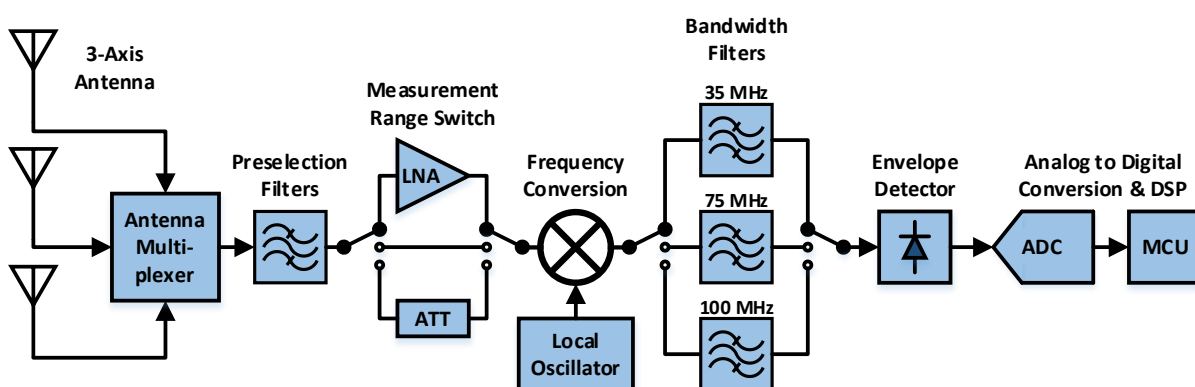

Figure 1: ExpoM-RF 4: Basic principle of operation

2 Case and interfaces

The standard enclosure of ExpoM - RF provides basic water and shock protection of the exposure meter. The case includes following control elements and interfaces (Figure 2):



Figure 2: ExpoM - RF 4 control elements: Marker button (1), Multi-color LED (2), Micro-USB interface (3), Charge indication LED (4), ON/OFF switch (5)

2.1. Multi-color LED

Status information about the operation of the device is given via the multi-color LED. The following table shows an overview about the color code and its corresponding behavior (Table 1).

Table 1

Situation	Multi-color LED
Powering on the device	1. White light: system initialization (device busy about 5 sec). 2. A "rainbow" color sweep signalizes successful initialization. 3. Yellow light (5 sec): device is ready for USB connection. After these initialization steps the devices switches into logger mode.
Logger mode	Short red flash after each measurement. If GPS is enabled, an additional green flash signalizes a successful GPS position fix.
Active connection to ExpoM-RF4 Utility or App	Solid pink light.
Wi-Fi connection to smartphone app	Blue flashing after power-up (about 10s): Waiting for Wi-Fi connection Single blue flash: Wi-Fi connection established. Solid pink light: Active connection to smartphone app. Double blue flash: Wi-Fi has been disconnected.
Marker button pressed	Blue light flashes up.
Downloading data	Blue light is constantly on while data is being downloaded.
Low Battery	Continuous yellow blinking every 2 seconds. <i>Note: If the battery voltage drops too low the device will turn off completely. Consequently, the LED will remain dark</i>
Device error	Red light is constantly on. A power cycle of the device is required.

2.2. USB interface and cable

ExpoM-RF 4 is equipped with a Micro-USB receptacle and is delivered with a corresponding cable that can be used both for charging and connecting to a computer. Although any standard compliant Micro-USB cable can be used with the device, it is recommended to always use the USB cable supplied with the device. This will ensure an efficient battery charging process and avoid data transfer problems.



Important notice: Avoiding damage to the USB receptacle

The Micro-USB receptacle is very durable and is specified to withstand at least 10,000 connect-disconnect cycles. We use standard micro-USB cables for all system variants. It is known that there are slight differences between them. However, this should not lead to problems if the USP plug is inserted correctly. Please observe following rules and when plugging in a cable into ExpoM-RF:

- Check the Micro-USB plug of the cable before inserting it. Replace the cable if there is any sign of damage like badly aligned, deformed pins or a bent outer conductor.
- Only very little force is required to insert the Micro-USB plug into the receptacle when it is correctly aligned. **NEVER force a cable into the receptacle. This will lead to irreversible mechanical damage to the USB interface.**
- Make sure that the cable is correctly aligned with the device. Following pictures show how the cable must be aligned and which situations must be absolutely avoided:

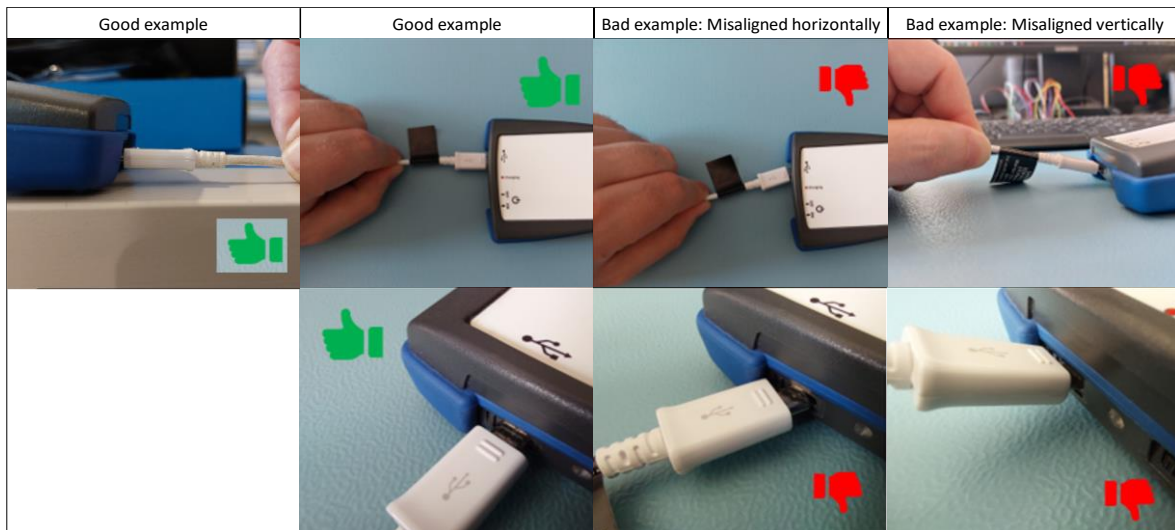

3 Using ExpoM-RF 4

3.1. Starting a measurement

As soon as the device is turned on by means of the ON/OFF switch and successfully finished its startup procedure it starts to measure and log the data using the data logger settings stored in the device (described in section 5.6.). The device can be turned on and off at any time. When ExpoM - RF 4 is powered on, a new measurement session (i.e. logger data set) is automatically started. All previously recorded data is preserved. The internal memory can only be cleared using the ExpoM - RF Utility on the PC (see section 5.2.).



Important notice: *During the measurement, the device should not be held in the hand nor be placed on a metallic surface. Both can influence the receiving characteristics of the built-in antennas and therefore influence the measurement. If it is required to use it as a handheld device, please contact the distributor for an additional calibration (additional calibration will cause additional costs).*



Important notice: *If the GPS is turned on make sure that the multi-color LED signalizes an established fix (see 2.1. Multi-color LED: Logger Mode) before you start your measurement tour. Especially if you are located in between obstacles such as high buildings this may take a while. In case that no connection is found, the GPS position in the exported data is set to '0' and won't be visible in a KML export!*

3.2. Setting a marker

The Marker button on the top of the device can be used to flag single measurement samples. The flagged samples are highlighted by means of an "x" sign visible in the measurement results after download.

4 Battery management

4.1. Charging the battery

The USB interface is used to recharge the internal battery or power the device from an external power source. Unless it is already fully charged, the battery is charging as soon as the device is connected to a powered USB source (wall adapter, PC, laptop etc.). Any compliant USB port and chargers providing at least 1000 mA can be used for this purpose. If the battery is almost full the charging process may not start automatically. In this case a charging cycle can be enforced by briefly switching on the device while the USB charging cable is plugged in.

While ExpoM - RF 4 is charging the battery, the charge indication LED near the USB receptacle lights up in solid red. At the end of the charging cycle the red light turns off. A full charge of a depleted battery can take up to 6 hours depending on the performance of the USB charger.



Important Notice: Using USB chargers that do not fulfill the USB dedicated charger port specification can lead to incomplete and slow charging process of the batteries. **It is strongly recommended to use an USB charger with a current rating of at least 1A (1000 mA).** More information about suitable USB charger types for ExpoM - RF can be obtained from the distributor.



Important Notice: Although it is possible to perform measurements while charging ExpoM - RF 4, it is inadvisable to do so. The charging cable influences the antenna characteristics, reducing the measurement accuracy. Frequency bands below 1 GHz are particularly susceptible to this effect.



Important Notice: At environmental temperatures above 45°C ExpoM - RF should not be charged. Direct exposure to sunlight during the charging process should be avoided.



Note: The actual charging time depends on the charger model and the type of USB cable used. Long and / or thin USB cables can significantly increase the required charging time regardless of which type of charger is used. It is recommended to use the USB cable provided with the device.

4.2. Over-discharge protection (automatic shutdown)

To prevent damage or loss of capacity, the internal battery must be prevented from being discharged below a critical level. ExpoM - RF 4 includes a battery monitoring circuit that powers the device down when a critically low battery level is detected. When the battery is depleted, it is recommended to switch ExpoM - RF off using the ON/OFF switch and charge it for at least 10 minutes before switching it on again.

5 ExpoM-RF 4 Utility (PC Software)

The ExpoM - RF Utility software is required for transferring and displaying the measurement data from ExpoM - RF 4 to a PC and for modifying the device and data logger settings. This software is currently only available for Windows operating systems.

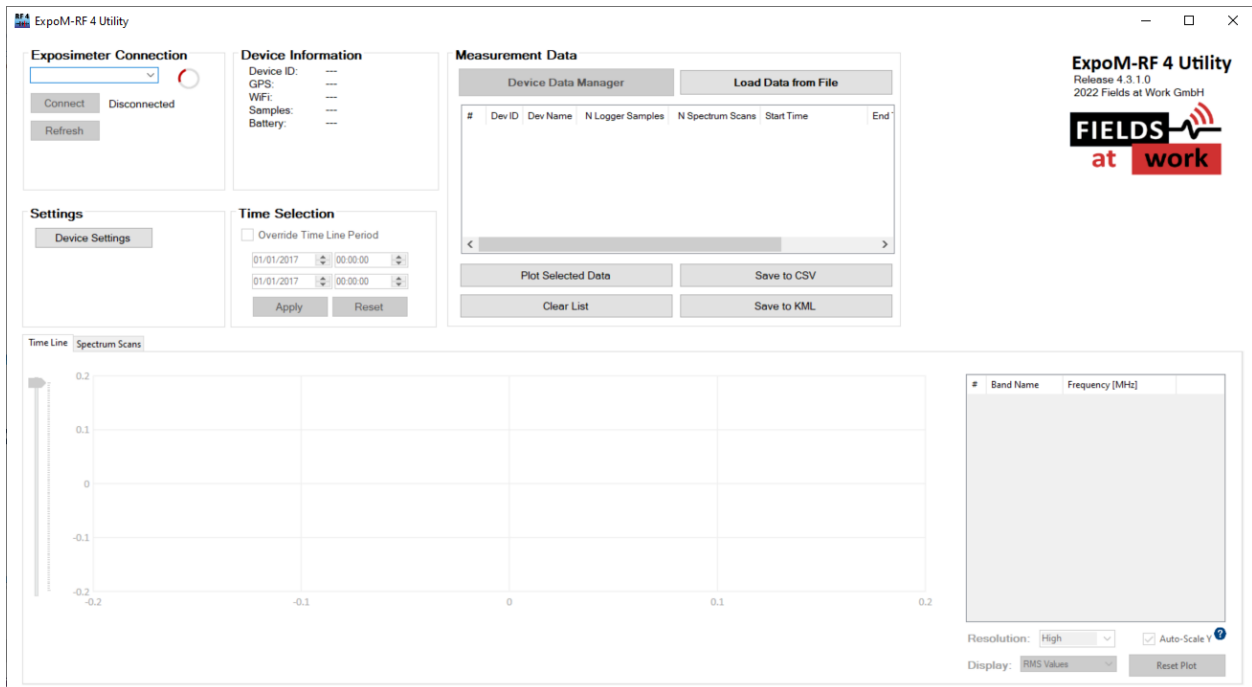

Figure 3: Main window of the ExpoM - RF 4 Utility software

5.1. Connecting to an ExpoM-RF 4 device

The procedure to connect the Utility to the ExpoM - RF 4 device is as follows:

1. start ExpoM-RF4 Utility on the PC
2. connect the ExpoM-RF 4 device to the PC using an USB cable
3. turn on ExpoM-RF 4.

On startup, Utility will try to detect any connected device. If it fails to do so, click the *Refresh* button in the *Exposimeter Connection* control element on the top left.

As soon as the device has been recognized, its device ID is display in the drop-down box.

Now click on the *Connect* button. As soon as a connection to the device has been successfully established, the basic info about the connected device will be shown in the adjacent *Device Information* section (Figure 4).

If the Utility is not able to make a connection to your device, please refer to chapter 5.7. and chapter 6.3.

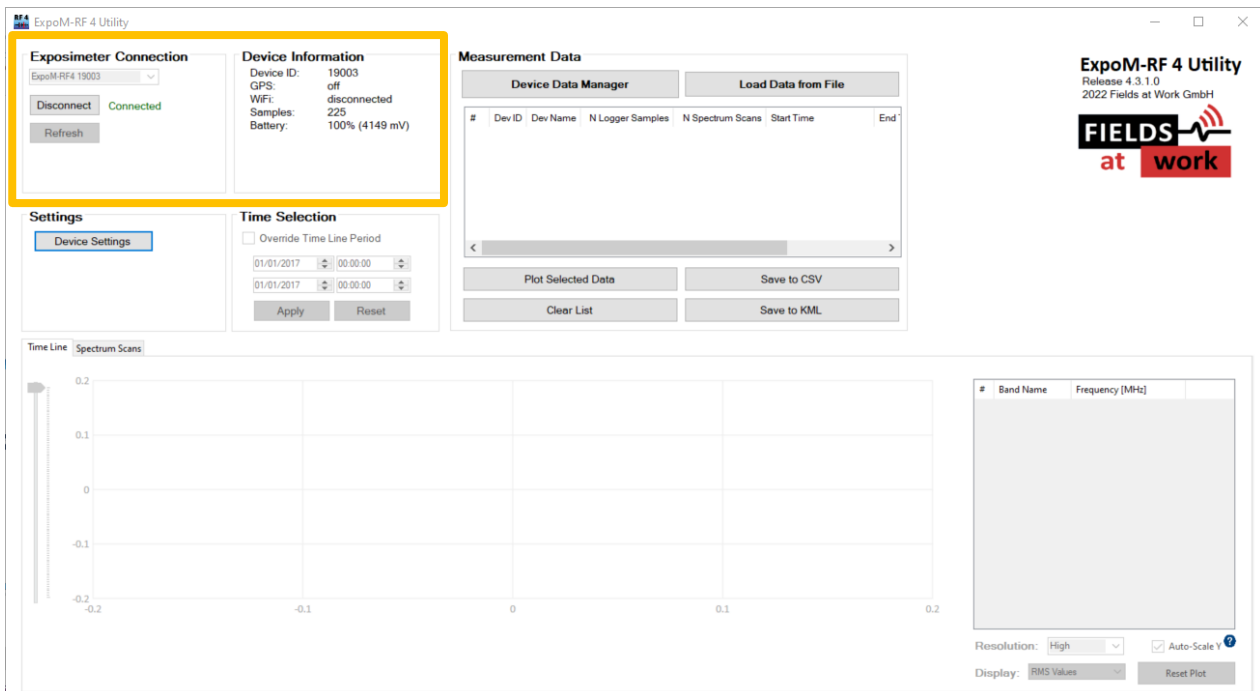

Figure 4: Main window (connection to device established)

5.2. Measurement data organization and download

ExpoM-RF 4 introduces a session-based organization of the measurement data. Every time that ExpoM-RF 4 is switched on, a new measurement session is automatically started and added to the existing ones. The device data manager (see Figure 5) lists all measurement sessions that are stored on the device. Each data set can be downloaded individually. The button *Clear Device* will delete **all data sets** stored on the device. Deleting individual data sets is not possible.

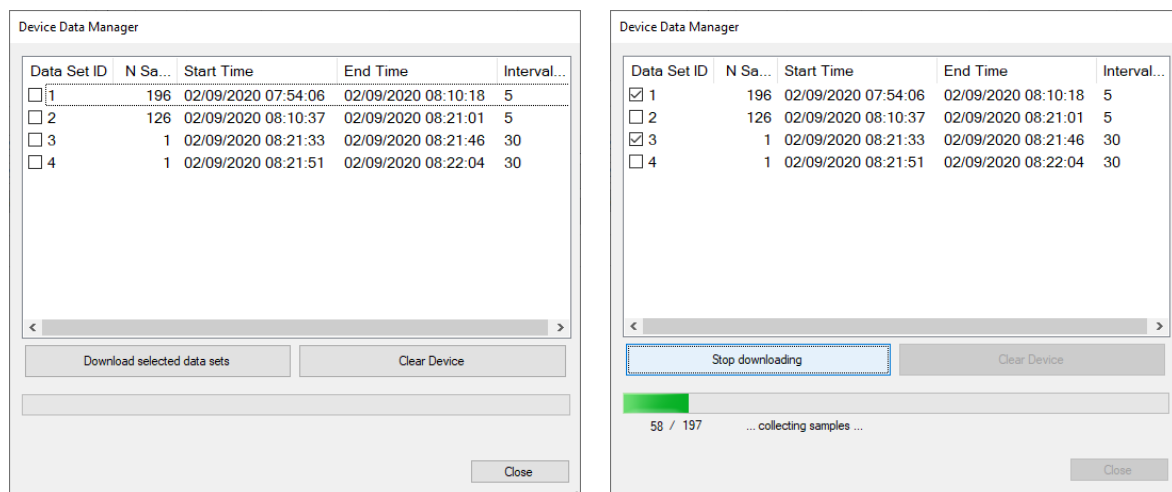

Figure 5: Device Data Manager window

Select the desired data sets by checking the corresponding boxes in the *Data Set ID* column and click on the *Download selected data sets* button. The data stored on the device is downloaded and transferred to Utility. The multi-color LED lights up in solid blue during the download process. This

operation can take several minutes depending on the number of measurement samples stored on the device, but the download can be interrupted at any time. Data sets that have been completely downloaded will be transferred to the Utility whereas partially downloaded data sets will be discarded. After completion of the download, the multi-colored LED turns to solid pink again. The device data manager window can now be closed. The transferred data sets appear in the *Measurement Data* section of the main window (Figure 6):

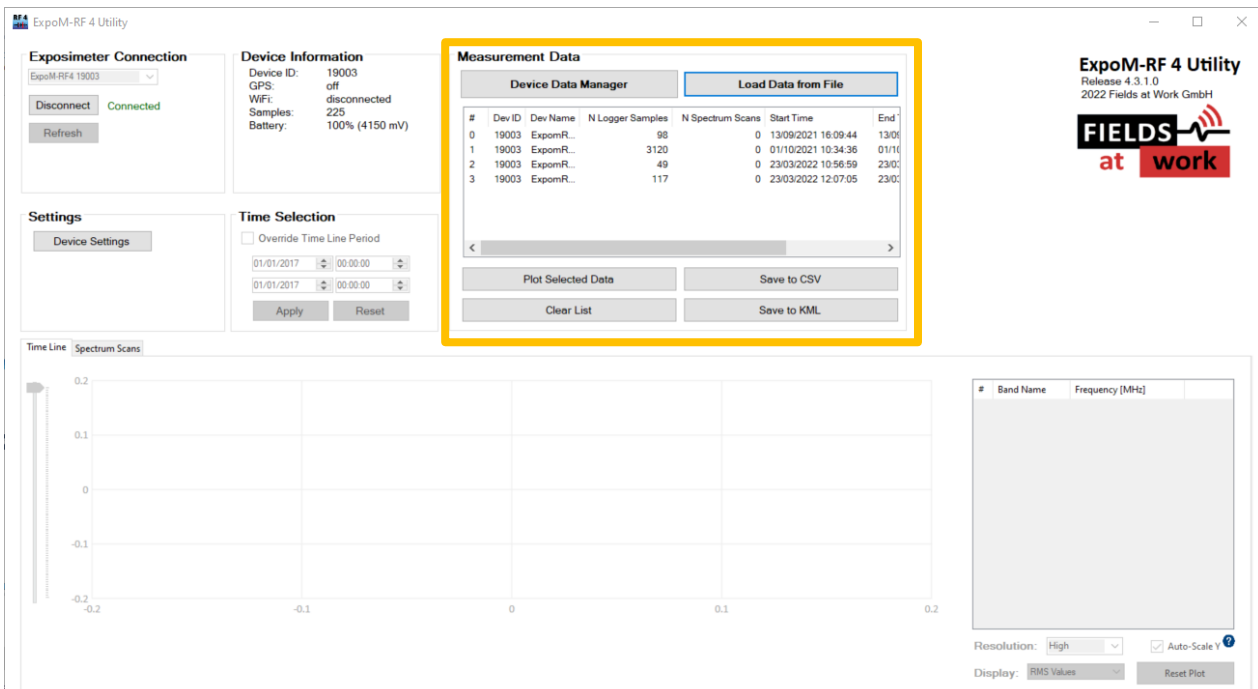

Figure 6: Main window showing four data sets

5.3. Plotting Data

To display the data, select one entry in the list and click on the *Plot Selected Data* button. This will also update the band list on the right of the plot according to the measurement (see Figure 7).

Panning, Zooming and Navigating the Plot

The graph is split into two sections: the *Main Plot* at the top and the *Preview Plot* below, which shows the same data in an overview perspective. Navigating the plot is usually done by clicking and dragging (*panning*) in the *Main Plot* window as well as using the mouse wheel to zoom in and out of points of interest. The area highlighted in red in the *Preview Plot* shows which part of the measurement is currently displayed in the *Main Plot*. This preview can also be clicked and dragged to browse through the measurement. To display the exact field strength value of a certain point in the graph, the mouse is hovered over the graph and a small tooltip pops up.

By default, the plot will always auto-scale the Y-Axis to fit the currently viewed largest values in the main plot window. This can be overridden with the *Auto-Scale Y* option in the *Additional Controls*. The *Vertical Trackbar* on the left can then be used to manually set the Y-Axis scale.

When navigating to a specific time window there is the *Time Selection* box above the *Main Plot*, which overrides any dragging input done in the *Main Plot*. Select the start and end time of your time window and hit *Apply*.

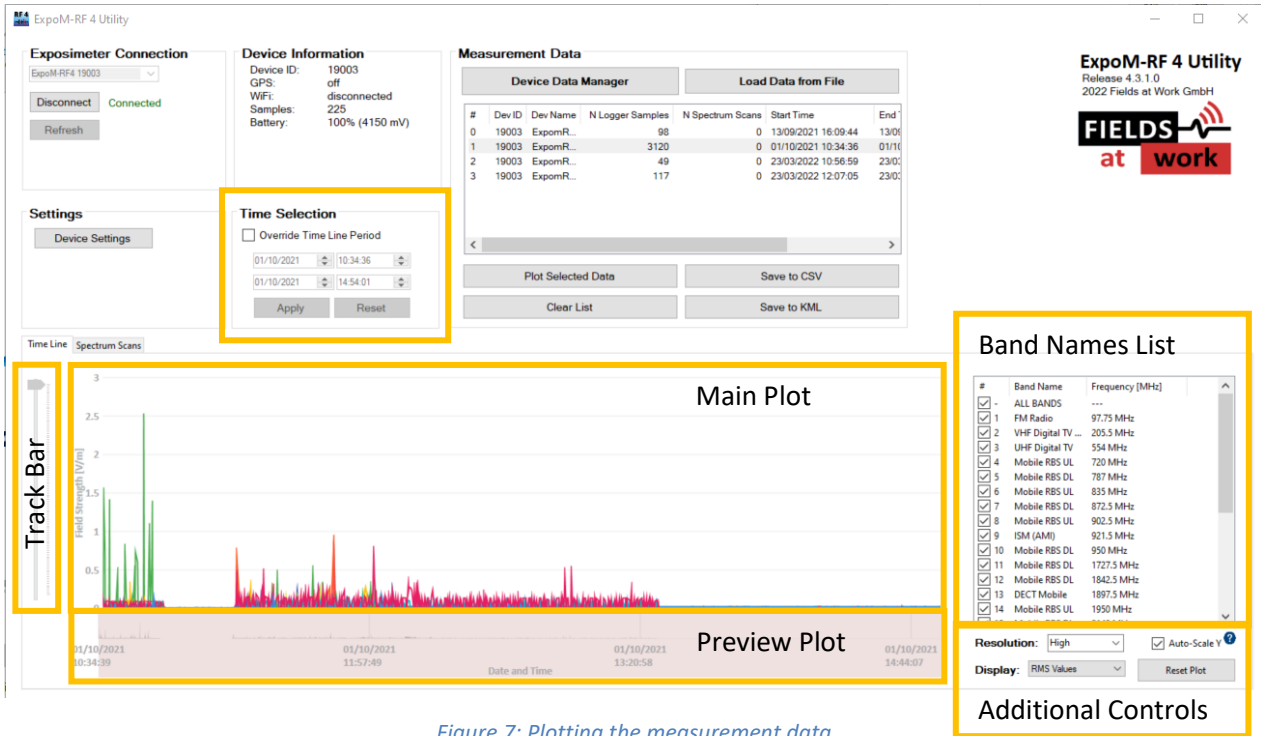

Figure 7: Plotting the measurement data

Band List

The band list on the right of the plot can be used to display only selected bands in the plot. Multiple bands can be selected by holding the Shift key (range selection) or Ctrl key (individual selection) while clicking on the items of the list. Additionally, the top item "ALL BANDS" allows to toggle ON and OFF the entire list of bands at once.

Plot Values

The *Display* dropdown menu lets you switch between the *Peak* and *RMS* measurement values of the currently displayed data set.

Plot Resolution

With the *Resolution* dropdown menu, the amount of detail displayed in the plot is changed. This can be used when working with extra-large data sets or when running Utility on a slower machine to fine-tune performance.

Note: The *Resolution* options simplify only the graphical representation in the main plot. The underlying measurement data is not affected by changing the resolution.

Reset Plot

The *Reset Plot* button in the *Additional Controls* reverts the plot to its original state. This resets any panning/zooming, any band selection or scaling changes done previously. Only the *Resolution* option remains as chosen before.

5.4. Saving the measurement data to file / data format

The *Save to CSV* button in the *Measurement Data* section will save the selected data set to a file. The default file name proposed by the software is composed of the Device ID, start date and time of the data set. Only one data set at a time can be saved. All bands including RMS and peak values are always stored to the file regardless of the data currently displayed in the plot.

ExpoM-RF 4 differentiates between two types of measurements. First, the normal measurements performed in logger mode according to the user-defined band list are referred to as *LOGGER* measurements. Second, if the device has been used to record frequency sweeps (i.e., spectrum overview scans), these measurements are stored in separate files because of the different number of bands requiring different number of columns in the file. Apart from that the data format is identical in the two files.

Both the *LOGGER* and the *SCAN* file start with a few lines representing the measurement description header. After that, one line is used to display the band names that can be set for each user-defined band. Then the measurements are stored in rows (one row for each measurement). The number of columns depends on the number of bands *N* that were measured in the exported measurement. The columns are organized as follows (Table 2):

Table 2

Column	Name	Format / Description
1	Date and time	MM/DD/YYYY hh:mm:ss
2	SEQ	Sequence number; incremented on every measurement in logger mode
3 ... N+3	[Frequency] (RMS) [Bandwidth]	RMS value of the field strength in V/m of the <i>N</i> frequency bands measured in the exported data set
N+4...2N+4	[Frequency] (PEAK) [Bandwidth]	Peak value of the field strength in V/m of the <i>N</i> frequency bands measured in the exported data set
2N + 5	GPS Fix	GPS validity indicator: 1 = Fix not available 2 = 2D fix (3 or less satellites visible, i.e., no accurate altitude) 3 = 3D, (min. 4 satellites visible, i.e. fully valid GPS fix)
2N + 6	GPS Lat	GPS Latitude: DDMM.mmmm D = degrees M = Minutes m = minute decimals)
2N + 7	GPS Lon	GPS Longitude: DDDMM.mmmm D = degrees M = Minutes m = minute decimals)
2N + 8	GPS Altitude	GPS determined altitude above mean sea level in meters
2N + 9	GPS HDOP	GPS accuracy indicator (lower = better) < 2 = very good 2-5 = OK

		> 5 = limited accuracy
2N + 10	GPS #Satellites	Number of satellites in view. Includes GPS and GLONASS satellites. Higher numbers mean higher localization reliability and accuracy
2N + 11	GPS Speed	GPS determined speed above ground in km/h. Unexpectedly high values may be registered when the satellite signal reception is bad (high HDOP value).
2N + 12	Marker	Tracks the number of marker button activations. The measurement that was active at the time the marker button was pressed contains the corresponding marker number.
2N + 13	Battery charge (%)	Battery charge level (in %) at time of sampling
2N + 14	Battery voltage (mV)	Battery voltage level (in mV) at time of sampling

5.5. KML Export

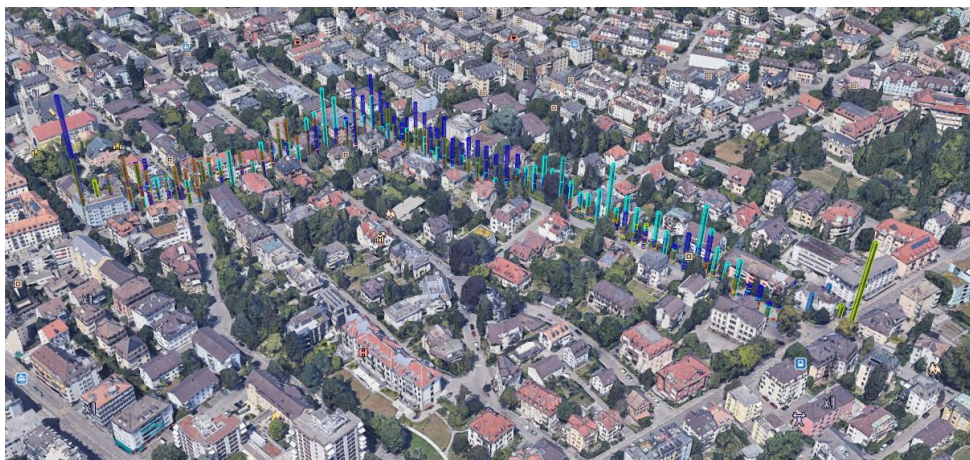

Figure 8: KML example on Google Earth

With a KML file you can visualize your measurement path and the corresponding field strengths on a map (e.g. Google Earth). To that end a KML exporter is integrated which can be entered by clicking on the *Save to KML* button in the *Measurement Data* section. This button will open the KML Exporter window as shown in Figure 9.

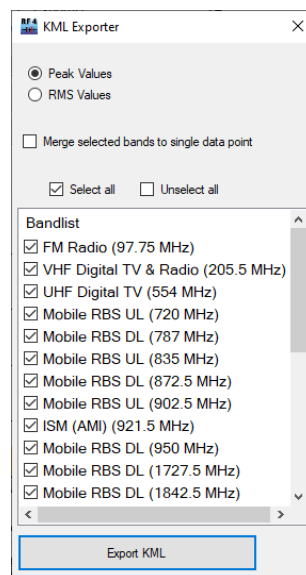

Figure 9: KML Exporter window

From there you can

- choose either peak or RMS values
- merge all bands from a measurement point into a single point which will contain the RMS sum of the selected bands
- deselect bands if you want to focus on specific bands only.

By clicking on the *Export KML* button the corresponding “.kml” file will be saved on your PC and can be opened in Google Earth (available at www.google.com/earth/versions/#earth-pro).

5.6. Device Settings

Changing the settings of a device requires it to be either connected to the ExpoM-RF 4 Utility or to the ExpoM-RF 4 App (for the App please refer to Chapter Figure 1). Some of these settings can also be changed when the device is used with the smartphone app. A click on the *Device Settings* button will display following window:

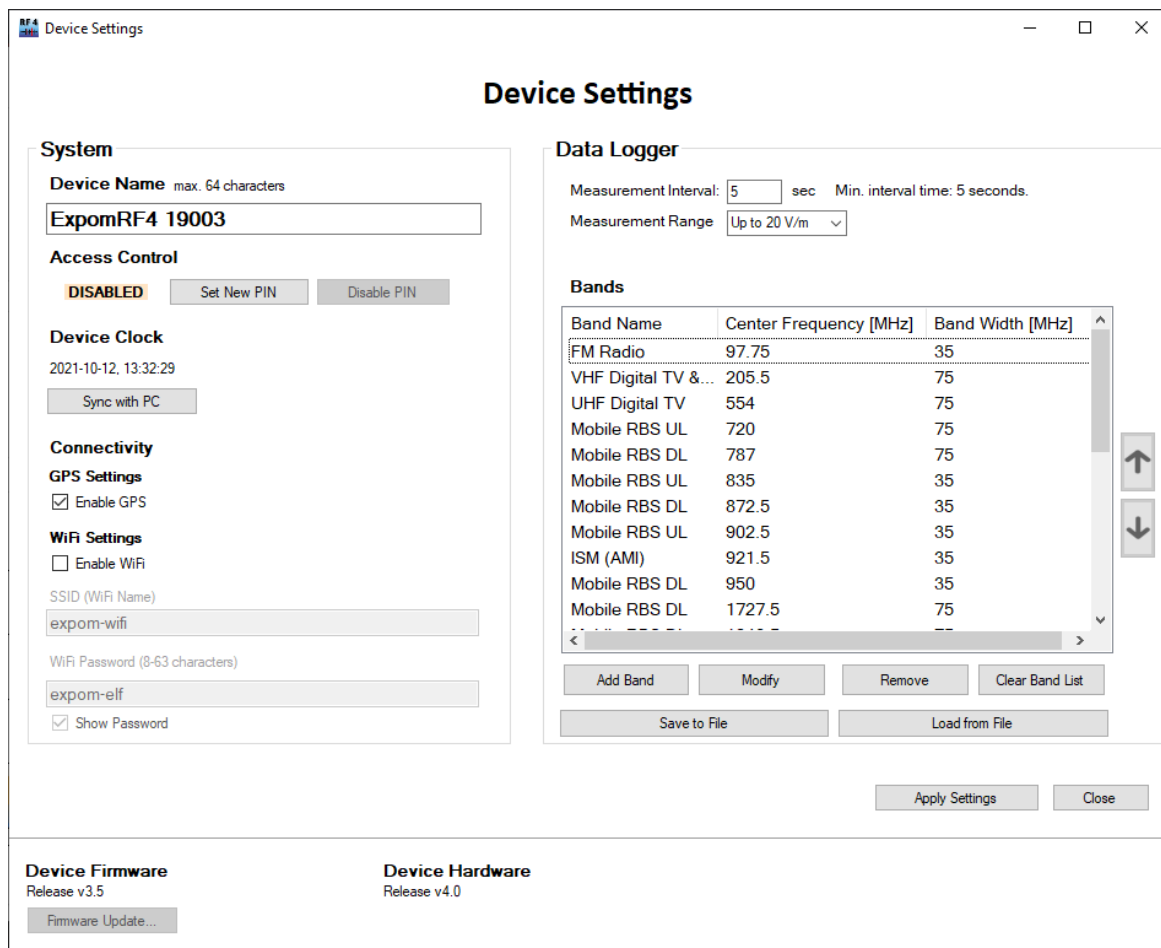

Figure 10: Device settings window

The device settings window is subdivided into two main sections: The *System* section, and the *Data Logger* section. For any changes to be applied on to the device, the *Apply Settings* button needs to be pressed.

System settings

The *System* section contains the general device settings:

Setting	Description
Device Name	A user defined name can be given to the connected device. The device name is shown in the exported measurement data and can be used to identify a specific device. The device name can be deliberately set and changed at any time. This field can also be left blank. (Device Name is not to be confused with Device ID that is unique for each device and cannot be modified.)
Access Control	The access to the device can be blocked by setting up a PIN code. Once set and disconnected from Utility, one can only access the device (Logger Data, Settings, etc.) by entering the previously set PIN. As long as a connection is established, a new PIN can be set, or the access control can be disabled. If the PIN is lost you can request a device specific PUK. To do so please contact the manufacturer.
Device Clock	Shows the time on the device's internal clock when the settings window was opened. The <i>Sync with PC</i> button synchronizes the device clock with the local computer clock.
GPS Settings	Enables the GPS localization on the device. Enabling GPS slightly increases the startup time of the device as well as the average power consumption during data logging.
Wi-Fi Settings	Enables the Wi-Fi connectivity on the device. Wi-Fi must be enabled to use the ExpoM-RF4 smartphone app (please refer to chapter 9 Smartphone App on page 31). Currently the SSID and its password are preset and can't be changed. To use the smartphone app the mobile hotspot provided by the smart phone must be set up as following: SSID: expom-wifi PW: expom-elf
SSID and Wi-Fi Password	<i>User settable SSID and password will be implemented in a future product update</i>



Important notice: *The accuracy and reliability of the GPS localization depends on the environmental conditions. Inside buildings and homes GPS localization may not be possible.*



Important notice: *After switching on the device, it may take several minutes for the GPS receiver to search for satellites. No position data will be logged during this time (the GPS data is set to 0). The first few measurement points may be inaccurate.*

Data logger settings

The *Data Logger* section contains all measurement related settings.

Setting	Description
Measurement Interval	This sets the measurement interval of the data logger. Longer intervals increase the runtime of the battery. The lowest possible sample interval is limited by the number of active bands (more bands longer measurement intervals). The device is programmed to always complete a measurement before taking a new sample. Choosing a sample interval lower than the recommended setting can lead to samples being skipped, i.e., taken at twice the selected sample interval. Please refer to chapter 10.3. 10.2. of this manual for minimum sample interval recommendations.
Measurement Range	The field strength measurement range of ExpoM-RF 4 can be adapted depending on the expected levels of exposure and detection priorities. The lowest setting (up to 6 V/m) provides the highest sensitivity for weak signals (lower detection limit) but is also more prone to signal saturation in presence of high field strength (i.e., nearby transmitting cell phone) which can lead to exposure underestimation because of momentary exceeding the specified measurement range of ExpoM-RF 4.
Bands	This is the list of frequency bands that will be logged on every measurement sample. The list can be extended and modified arbitrarily. Up to 200 bands can be defined. However, using a band list with an excessive number of entries will lead to low battery runtimes and long minimum sample intervals (e.g., 25 bands will have a minimum interval of 5 seconds, whereas 200 bands require an interval of at least 31 seconds). Each band can be customized by changing the center frequency, band width and assigning a band name. The latter is also displayed in the plot and saved in the data export. Deleting all bands and saving this empty band list onto the device will trigger the device to load its factory default band list upon next reboot.

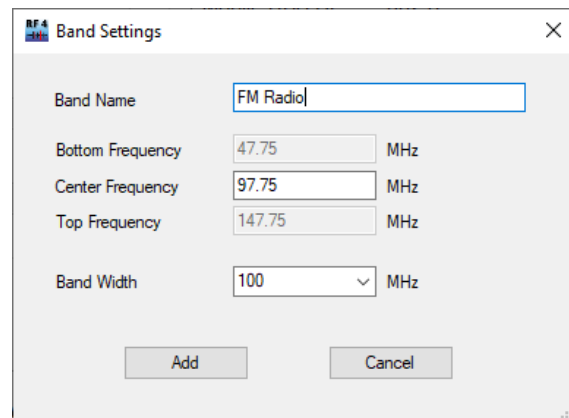
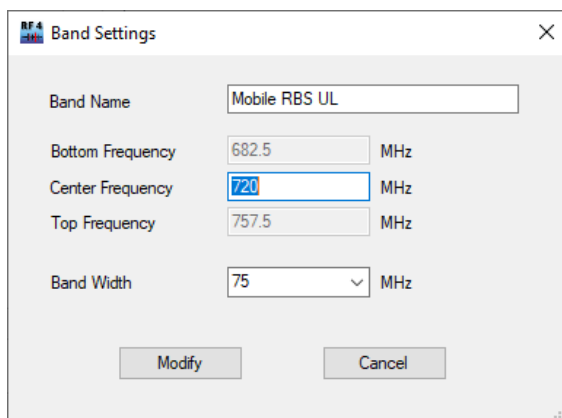

Figure 11: Adding a new band to the bands list (left); Modifying an existing entry of the bands list (right).

5.7. Setting up PIN lock

PIN

If it is required to prevent unauthorized access to the device (logger data, device settings, etc.), the access can be controlled by settings up a PIN for the device:

1. Plug in the device to the PC, open Utility and connect to the device.
2. Open the *Device Settings* window.

On the left-hand side, you will find the section *Access Control*.

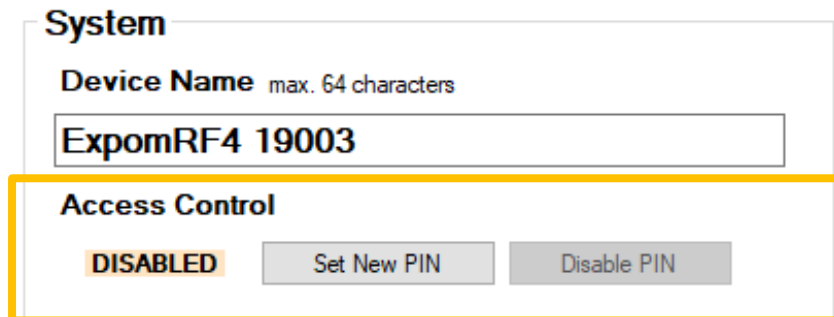

The screenshot shows a 'System' settings window. Under 'Device Name', there is a text field containing 'ExpomRF4 19003' with a 'max. 64 characters' label. Below this, the 'Access Control' section is highlighted with a yellow border. It shows a 'DISABLED' status, a 'Set New PIN' button, and a 'Disable PIN' button.

3. Click on *Set New PIN*.

As long the device remains connected this PIN can be disabled or a new PIN can be set. Once the device got disconnected the device is locked. When connecting again to the device, ExpoM-RF 4 Utility will request its corresponding PIN.



Important notice: Locking a device with a PIN also prevents to connect to the device using the Android App.

PUK

If the PIN of a locked device is lost, the device's PIN can be overridden using a device specific PUK. This will reset the PIN and unlock the device. Please request that PUK from the manufacturer.



Important notice: Any data (logged measurements, settings) will remain on the device and will not be deleted if the access is forced using the PUK.

5.8. Firmware Update

To update the firmware on a device, follow the steps below:

1. Download the latest firmware (.hex file) from our website¹.
2. Open Utility (keep the device disconnected).
3. In Utility click on *Device Settings* and open the *Firmware Update ...* window.
4. Follow the steps in the *Firmware Update ...* window.

¹ Make sure that you are up to date with the latest Utility as well. You can upload any firmware release with any Utility release, but they may not be compatible or at least certain functions may not be available.

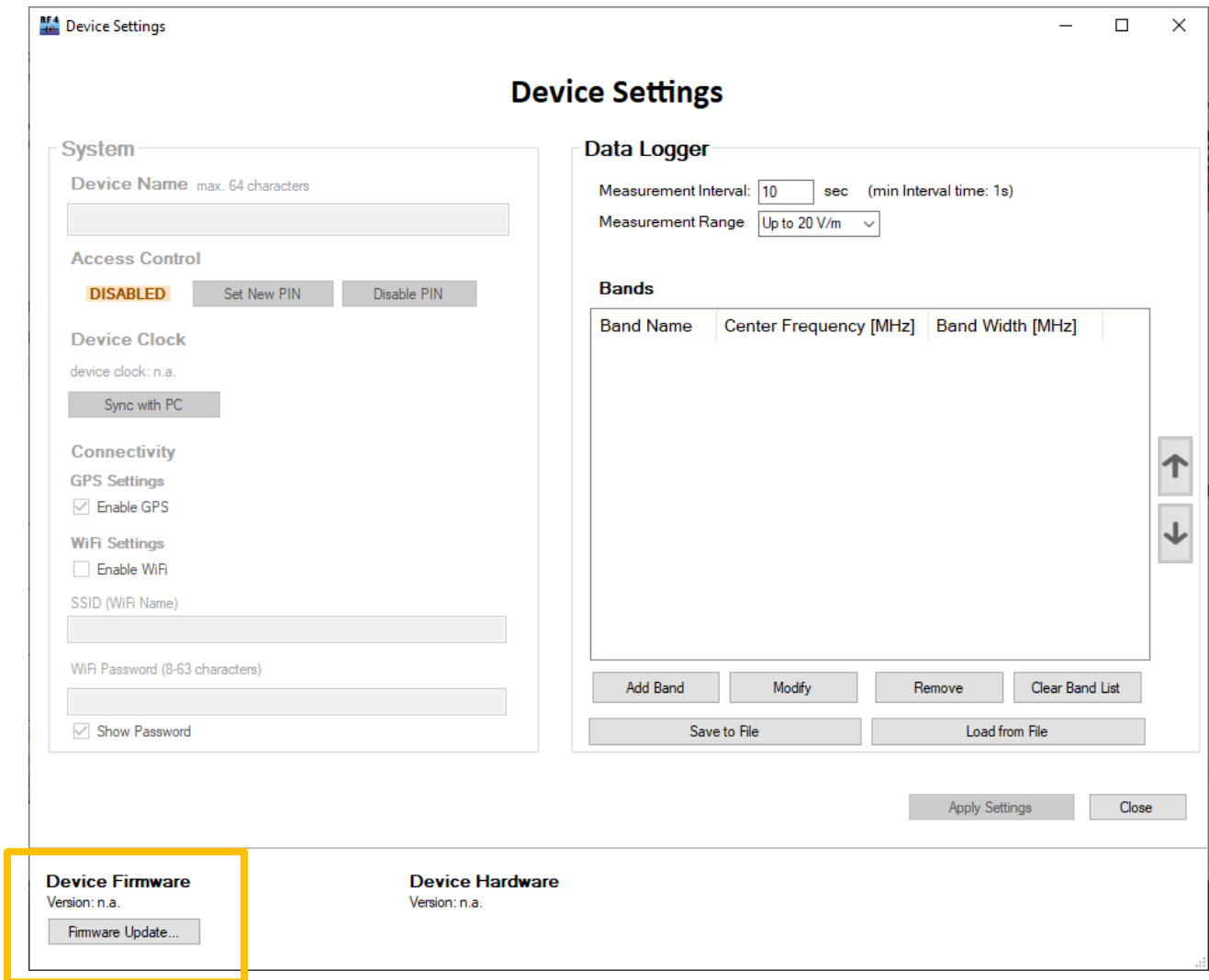

Figure 12: Device Settings window showing



Figure 13: Firmware update window.

5.9. Spectrum Scan (Spectrum Analyzer Mode)

While the device is connected to Utility (see 5.1.), the user can perform a spectrum scan. This feature performs a gapless measurement across the full frequency range of the device (0.05 - 6 GHz) using the 35 MHz bandwidth filter. The spectrum analyzer mode can therefore be used to detect RF activity at frequencies which may not be necessarily part of the logger bands.

Important Note: The spectrum analyzer feature is available on all ExpoM-RF 4 devices, regardless of the chosen calibration option. However, the field strength values of the spectrum shown by devices calibrated with the basic calibration option (option 1, list of 25 bands) will not be calibrated over the full range of the device and therefore exhibit a larger uncertainty. The extended or full calibration option is required to get calibrated readings over the full frequency range of the spectrum scan.

Select the *Spectrum Scan* tab control as shown in Figure 14. Click on the *Run Scan* button located on the right side of the chart. The scan will take about 15 seconds.

As soon as the spectrum scan is accomplished the result will be downloaded to the Utility and displayed immediately (Figure 15). It is also stored on the device and is accessible using the device data manager (see chapter 5.2.). It will appear as a separate data set containing one spectrum scan.

When the spectrum scan data is plotted, the user can switch between RMS and peak values using the drop-down list located below the *Run Scan* button (see Figure 14).

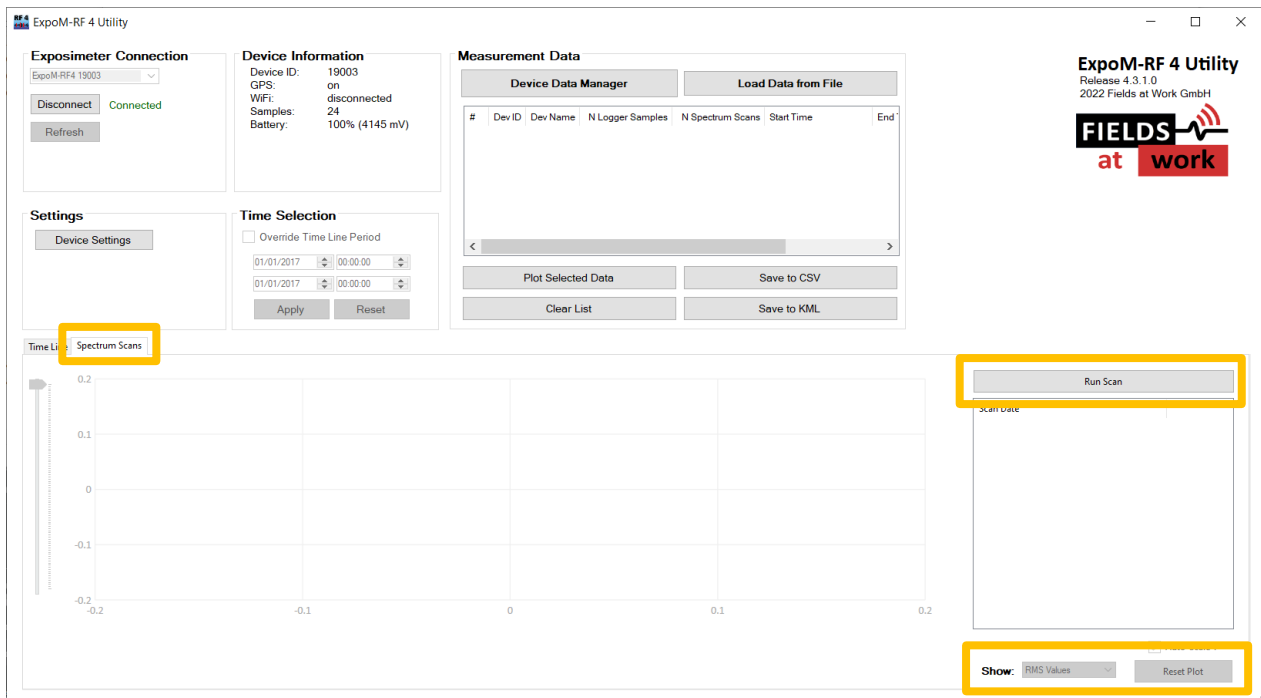

Figure 14: Selecting the spectrum scan feature

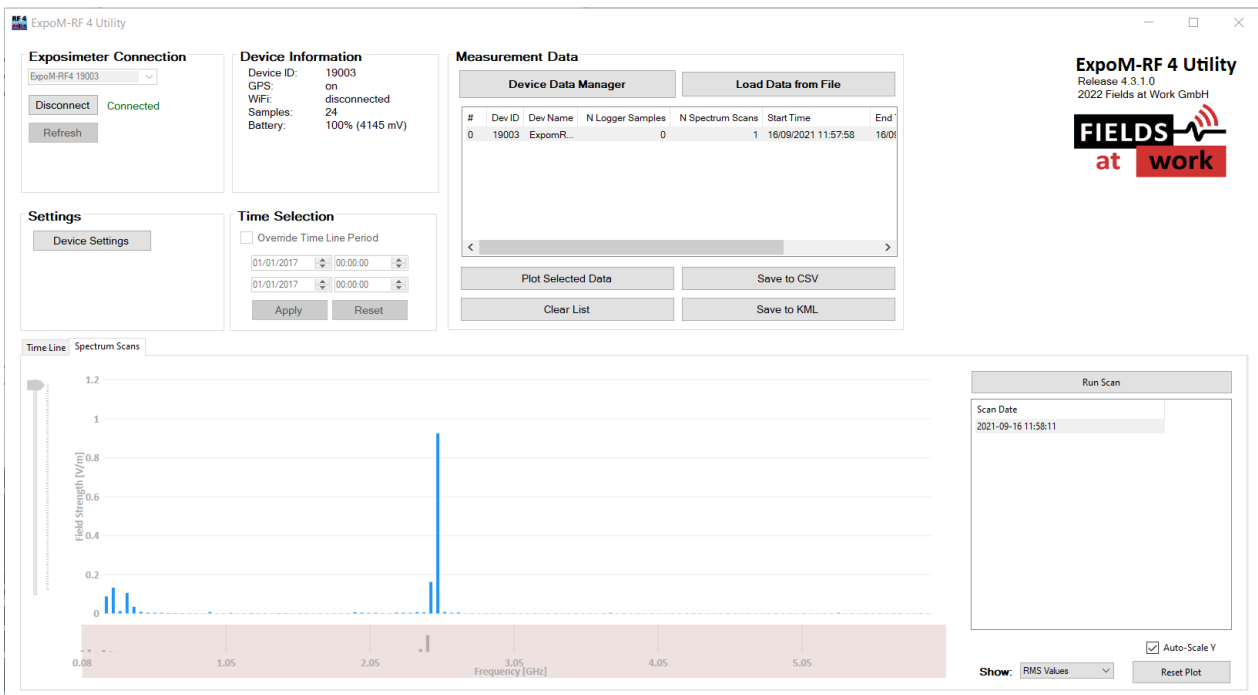

Figure 15: Displaying the results of a spectrum scan

5.10. Installing the USB driver

The USB driver required for ExpoM RF is included with most Windows versions and is automatically installed the first time ExpoM - RF is connected to the PC. Make sure that the device is switched on the whole time. It might take a few minutes for the corresponding COM port to become available when ExpoM-RF is connected to the computer the very first time.

If the automatic driver installation fails, however, it is necessary to install the driver manually. The driver can be found on the FTDI web address².



Important notice: *The Installation of the USB driver requires administrator rights for the computer.*

² <https://www.ftdichip.com/Drivers/CDM/CDM%20v2.12.36.2%20WHQL%20Certified.zip>

6 Troubleshooting

6.1. How can I improve the battery runtime?

There are several ways how the run time of ExpoM-RF 4 can be improved:

- Disable GPS if not necessarily needed. The effect of this measure is most noticeable when long sample intervals are selected
- Increase the measurement interval
- Reduce the number of bands in the logger settings

6.2. The device does not charge the battery

Under certain circumstances the charging LED might not switch on even though the charger is plugged in. Charging of the battery can be forced by briefly switching on the device until the LED rainbow appears (see 2.1.). If this does not help either, the battery is probably already charged to more than 95%.

6.3. Device not recognized

Scenario: You have opened the utility and connected the device to your computer. ExpoM-RF Utility does not list the device ID, even after clicking the *Refresh* button a few times (see example in Figure 16).

Be aware that sometimes it may take a few seconds for the computer to recognize the USB interface of the ExpoM-RF4. Reconnecting it to the computer and restarting the device may help.

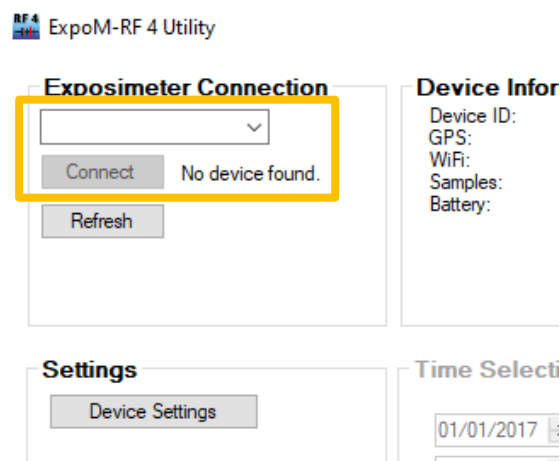

Figure 16: Failed to find connected ExpoM-RF4 → none found.

Troubleshooting

- Restart Utility: While having the device turned on and plugged in to the computer, restart the utility and check again.
- Choose other USB Port: You may try to connect the device to another USB slot (you may avoid USB hubs or docking stations. Mostly it's not an issue but sometimes they simple won't recognize connected devices.)
- Consider Device Manager: If nothing helped so far use the *Device Manager* to check the connection:
 - a. (Press *Windows* key and type "Device Manager")
 - b. Check if the table contains *Ports (COM & LPT)* (see Figure 17). If it does, check if one of the listed USB serial ports belongs to your device. Simply unplug the device and check if any listed USB device disappears (you may re-enter that list to make it update). In case the device shows up in *Other Devices* instead of *Ports (COM & LPT)* (see Figure 18), the operating system (i.e. Windows) hasn't recognized it yet. In this case it unfortunately can take up to a few minutes until it gets recognized correctly as a COM & LPT. Plugging it into a different USB port may help as well.

If no port is disappearing from the list, then your device wasn't part of it. Consequently, the device is not recognized at all. In this case the corresponding driver is probably not installed. Please refer to chapter 5.10. Installing the USB driver.

If you could identify your device in the list but it still doesn't appear in the utility, then there might be a major issue. Please contact us for further support.

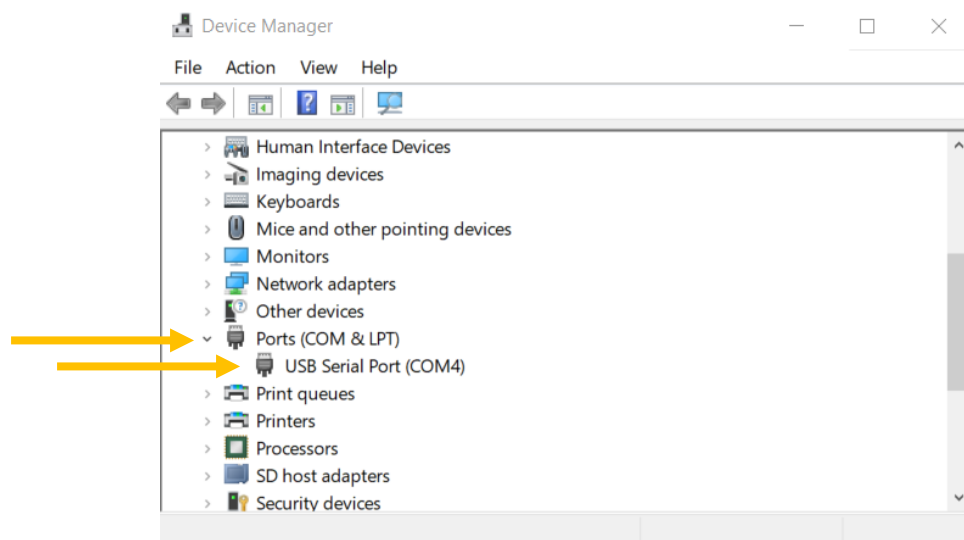

Figure 17: How it should be: Device Manager recognized device correctly as USB Serial Port (COM...) in Ports (COM & LPT).

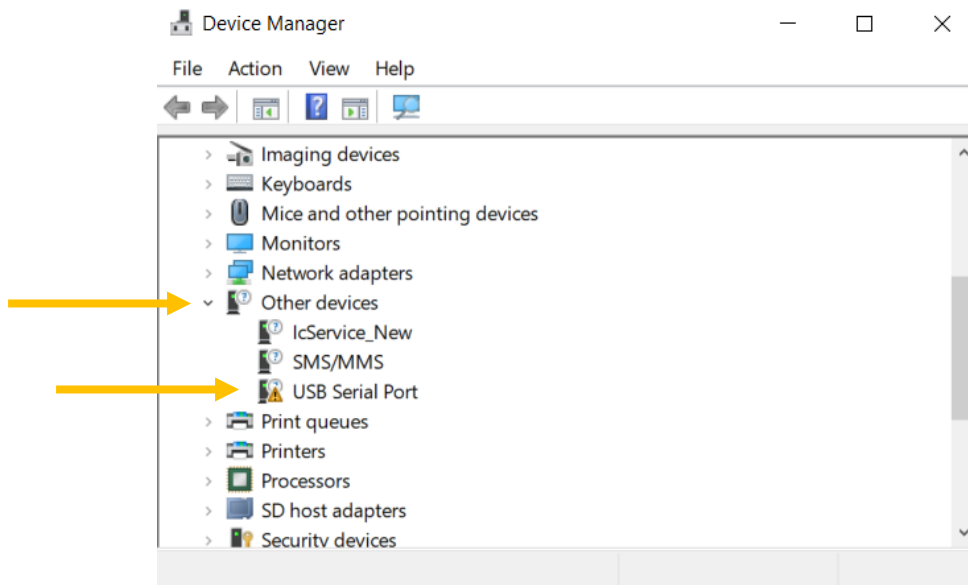

Figure 18: How it is: Device Manager recognized device as USB Serial Port in Other devices.

6.4. Window Display Issues

You may face the issue in which a specific window is not displayed correctly, i.e. an edge may be cut off. This can occur on computers with combinations of low display resolutions and/or high display scaling factor.

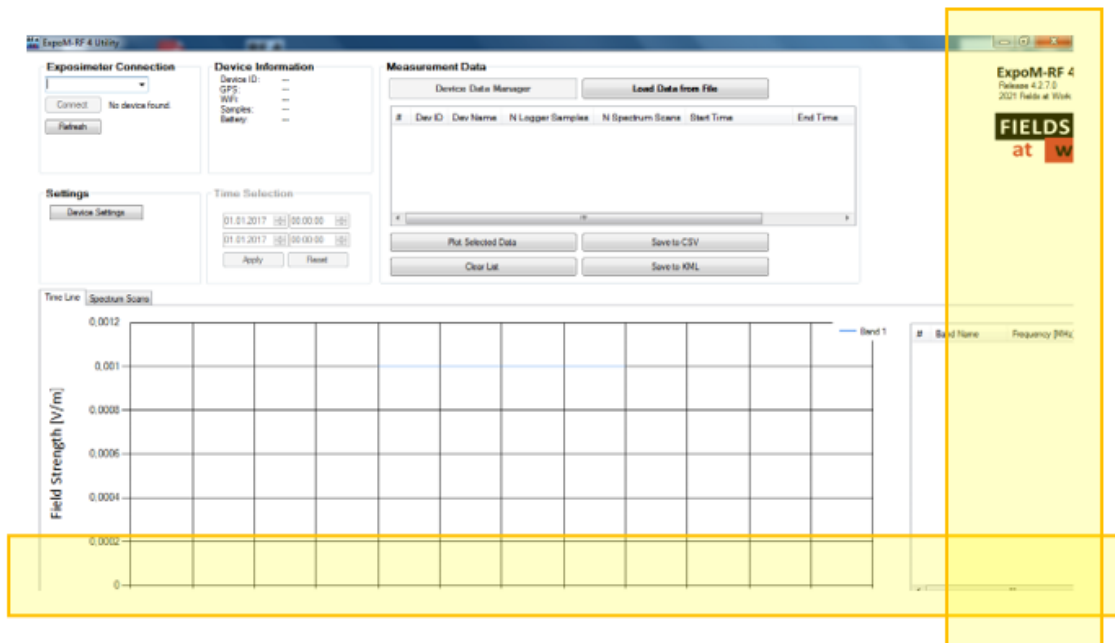

Figure 19: Erroneous scaling of the display.

In this case open the display settings (right click on empty space of your desktop and select "Display Settings") and select any higher resolution (if possible) or decrease the scaling of your Windows to 100 or 125 %.

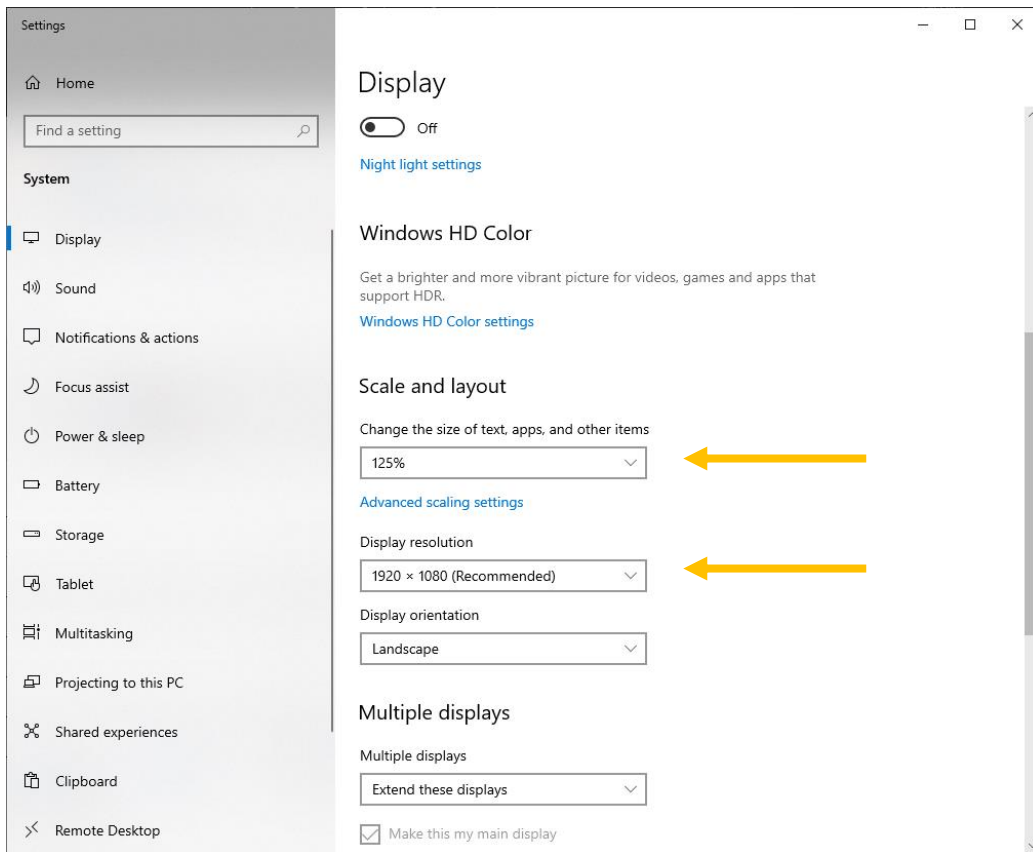

Figure 20: Changing display settings.

Another setting that can interfere with properly scaling the application is Window’s “Fix scaling for apps” option. This can be found in the “Advanced scaling settings” (as seen in Figure 21) and should preferably be turned OFF for more consistent results. This is useful when for example some buttons and texts are disproportionally large or overlapping one another.

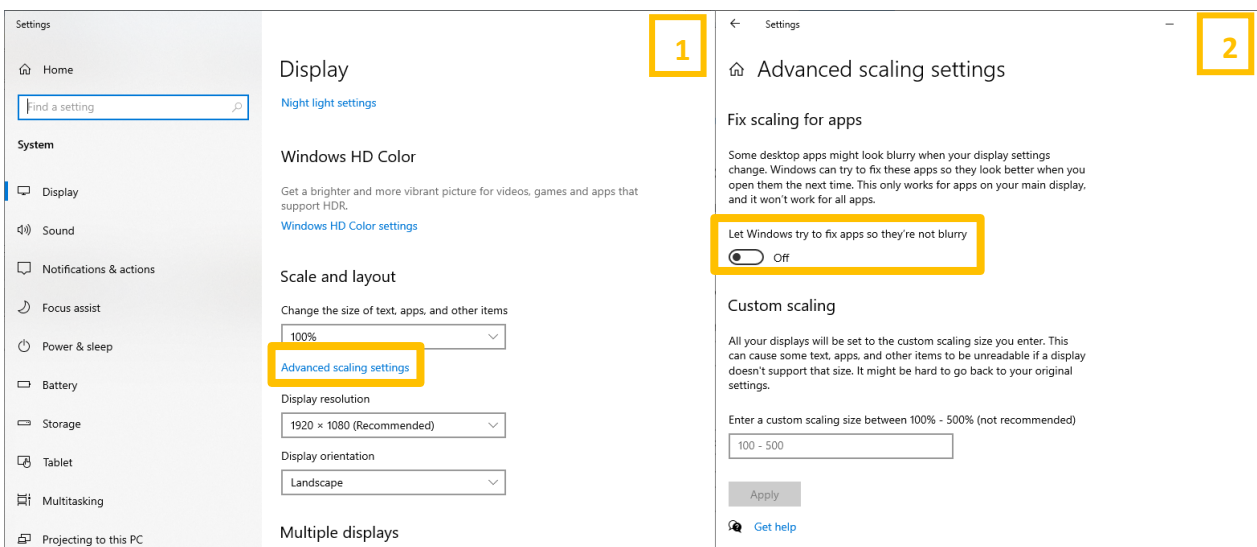

Figure 21: turning advanced scaling OFF.

If this still doesn’t solve the problem, please contact the manufacturer.

7 Device Calibration Options

This chapter gives a general information on the available calibration options and how the user settings can impact the measurement uncertainty.

7.1. Basic calibration option

The basic calibration option includes a set of 25 frequency bands which are calibrated in the anechoic chamber. The band list can be specified by the customer at the time of ordering.

Each of the 25 bands can consist of any combination of center frequency and bandwidth allowed by ExpoM-RF 4. This option is recommended for customers who are mainly interested in the assessment of the personal RF-EMF exposure from cell phones, base stations, and other wireless consumer electronics. Accordingly, a very common choice for the band list consists of the local cellular uplink and downlink frequency bands plus the 2.45 GHz and 5 GHz ISM bands.

For any measurements performed with center frequency / bandwidth settings which are not part of the list, the calibration factors will be interpolated and therefore exhibit higher measurement uncertainty.

7.2. Extended calibration option

The extended calibration option includes the set of 25 calibrated custom frequency bands like the basic option. In addition to that, a high frequency resolution calibration for the 35 MHz bandwidth setting is performed in the anechoic chamber over the full measurement range of the device (0.05-6 GHz). This option is required to get calibrated field strength values with the spectrum scan feature.

With this calibration option, any band setting in the data logger using the 35 MHz bandwidth will be calibrated as well.

For any measurement performed with a center frequency / bandwidth setting which is either not part of the list of 25 custom bands, or using a different bandwidth than 35 MHz, the calibration factors will be interpolated and therefore exhibit higher measurement uncertainty.

7.3. Full calibration option

The full calibration option includes the set of 25 calibrated custom frequency bands, plus a high frequency resolution calibration in the anechoic for all available bandwidth filters (35, 75, and 100 MHz) over the full measurement range of the device (0.05-6 GHz).

This option enables calibrated spectrum scans as well as calibrated measurements using any arbitrary center frequency / bandwidth combination for the data logger bands.

8 Crosstalk optimizations

Today’s frequency band allocations in most countries are tightly spaced and the spectrum is quite crowded. Especially in the range below 2 GHz, frequency bands with very different average power levels and activity patterns (such as uplink and downlink bands of cellular bands) are often well below 100 MHz apart. For exposure measurements, a clear separation of the individual contributions of the various frequency bands is highly desirable. ExpoM-RF 4 is therefore designed to achieve very good frequency selectivity across its entire measurement range of the device. The idealized response of a bandpass filter would look like a “brick wall” in the frequency domain, passing all frequencies within the desired bandwidth and completely rejecting all other frequencies. In practice however, there is a steep but finite transition region between the passband and rejection band. If ExpoM-RF 4 is set to measure two bands which are very closely spaced, the actual pass band response of the filter set to band A may partially extend into the adjacent band B, leading to part of the energy of band B being measured also when measuring band A. This effect is referred to as crosstalk and is illustrated in the picture below.

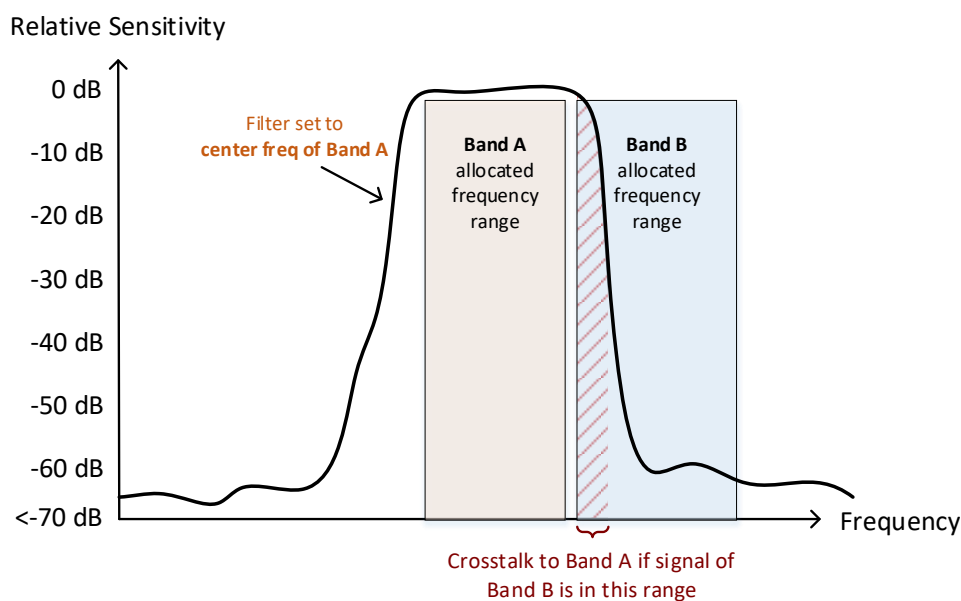

Figure 22: very closely spaced frequency bands can exhibit crosstalk effects due to “frequency spill-over” effects arising from the finite passband to stopband transition of the ExpoM-RFs bandwidth filters.

If you are faced to very challenging measurement situations in which any crosstalk effect must be kept to the absolute minimum possible, the flexibility of ExpoM-RF 4 allows to optimize the crosstalk performance for specific measurement settings.

By default, the center frequencies defined in the band settings of the device are set to the nominal center frequency of the corresponding band allocation (i.e. 942.5 MHz for E-UTRA band 5 downlink). This makes sure that the band to be measured is perfectly centered within the measurement frequency response of ExpoM-RF 4. However, the actual bandwidth of the frequency response is slightly larger than the nominal bandwidth to account for tolerances and to have some margin to

the band edges of the filter. For this reason, shifting the center frequency of a band in the measurement settings by a few MHz will not make any noticeable differences in the measured field strength in most cases. On the other hand, this very same small frequency shift will drastically reduce crosstalk contributions from the adjacent band. The figure below illustrates this principle when the measurement frequency is slightly offset with respect to the nominal center frequency of an allocated band.

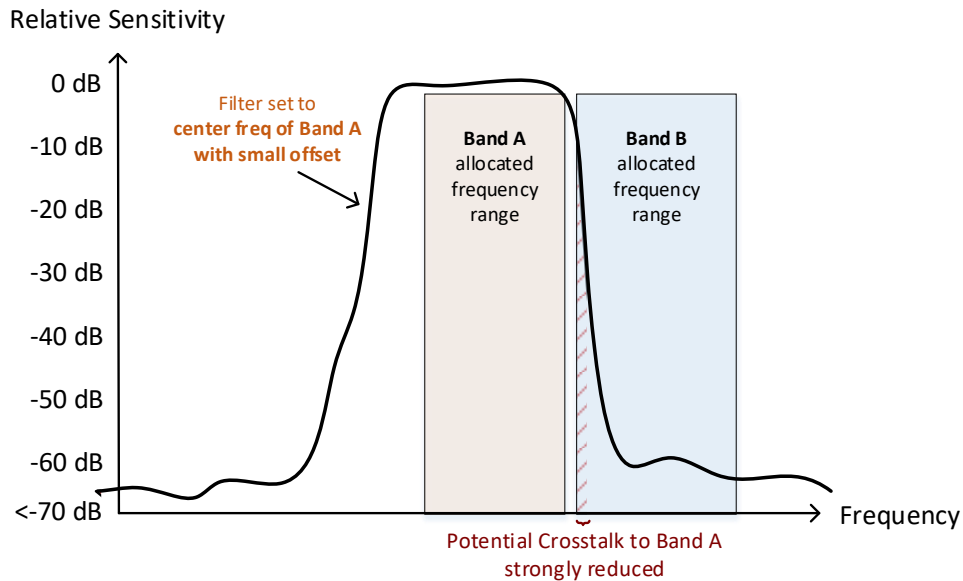

Figure 23: Optimized band settings can largely mitigate crosstalk effects due to tight band allocations.

Please contact us if you need more information or support regarding the band list optimization.

9 Smartphone App

9.1. Introduction

The smartphone app establishes a Wi-Fi connection to ExpoM-RF 4 and allows to display the measured field strengths in real-time. The spectrum scan functionality gives an overview of the field strengths over the entire frequency range covered by the device.

9.2. Device Setup

Connecting the app to a device requires Wi-Fi to be enabled on the ExpoM-RF 4 device. This is accomplished using the utility. Please refer to chapter 5.6.

You cannot use the Utility via USB cable and the app simultaneously. Therefore, disconnect the ExpoM-RF 4 device from the ExpoM Utility software first in case it should be still connected.

9.3. Installing the App

The ExpoM-RF 4 app is not yet available through the Google Play Store. The app must therefore be downloaded and installed as so-called third-party app in form of an APK file.

Visit the ExpoM-RF 4 product page using your Android device and download the ExpoM-RF4 App³. Open the downloaded APK file. You may have to allow your browser to install third party apps.

For the app to work correctly, the Android App requires the permission to access the local storage. Once that is set, you are now ready to go.

9.4. Starting the App

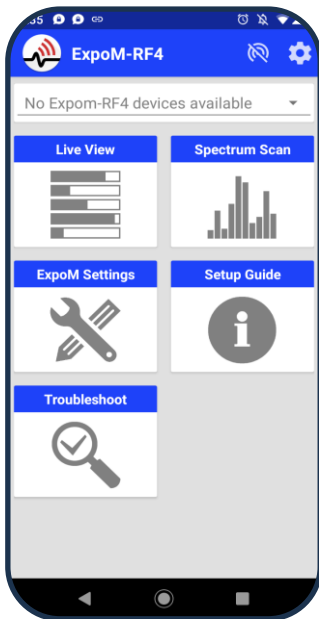

Figure 24: Setup Guide

When the app is started, a setup guide will appear that will explain how to connect to a device (the setup guide can be skipped if you are familiar with the process).

³ <https://fieldsatwork.ch/products/expom-rf/expom-rf4/>

After leaving the setup the main window presents the following options:



- Live View
- Spectrum Scan
- ExpoM Settings
- Setup Guide
- Troubleshoot

Figure 25: Main window showing all available options

9.5. Connecting to a Device

For instructions on how to connect to an ExpoM RF 4 device using the Android App, please reference the setup guide in the Android App. This guide is displayed when running the app.

9.6. Live View

When entering live view the device will automatically start to take measurements according to the stored frequency band list and display the measurements. All measurement taken with the app are also logged to the internal memory of ExpoM-RF and can be downloaded later using the utility.

The plot will show either the RMS or the peak values or both simultaneously.

Change displayed data (RMS, Peak or both simultaneously).

Refresh button. Long tap: change from automatic (default) to manual mode

Change text size (small - medium - large)

A bar will give a visual impression of the current field strength.

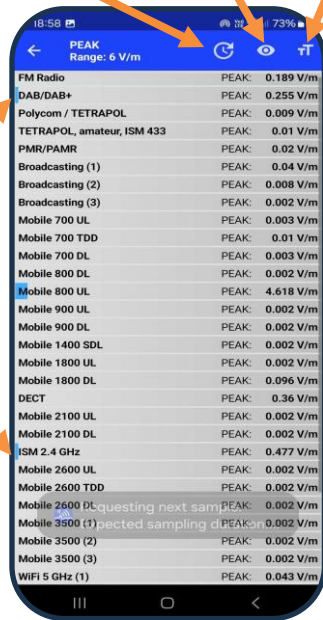

Figure 26: Live View

9.7. Spectrum Scan

The spectrum scan feature allows to take a measurement over the entire frequency range covered by the device (please refer to chapter 5.9. on page 21 for more information about the scan feature).

The plot will show either the RMS or the peak values, or both simultaneously. Zooming closer into the plot (using the zoom button) it will also display the corresponding numerical values on top of each bar.

Start a scan. Change displayed data (RMS, Peak or both simultaneously).

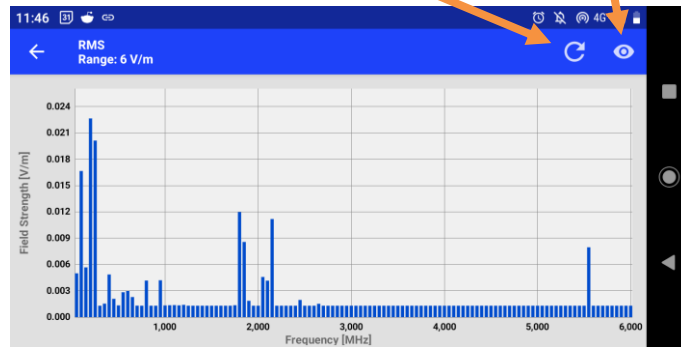

Figure 27: Spectrum Scan View

It is recommended to use the spectrum scan view in horizontal mode. The plot can be zoomed in and out using two fingers and reset to default by a double tap.

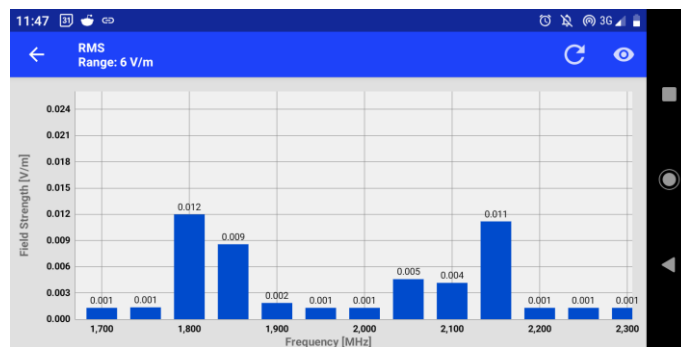
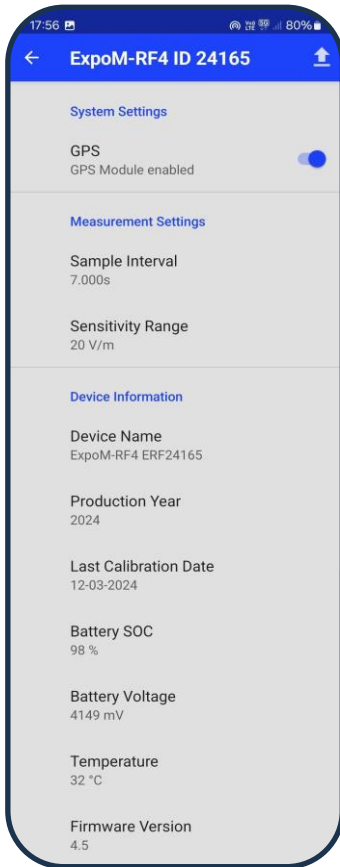

Figure 28: Spectrum Scan View - zoomed in to display the numeric field strength values

9.8. ExpoM Settings



The ExpoM Settings perspective provides control over the following settings:

- System Settings: Enable/disable GPS
- Measurement Settings: Sample Interval, Sensitivity Range

Additionally, the following Device Information is displayed:

- Device Name
- Production Year
- Last Calibration Date
- Battery SOC
- Battery Voltage
- Temperature
- Firmware Version

9.9. Setup Guide

This guide shows how a device can be connected to the app. It will always show up when the app is started (unless it is disabled in the app settings).

9.10. Hardware Requirements

A connection to the ExpoM-RF4 can only be established when the Android device can set up a Wi-Fi Hotspot. This usually requires a device equipped with a SIM-card slot. Depending on the device manufacturer and installed Android version, third-party apps might be required to activate and configure the Wi-Fi hotspot if no SIM card is present.

9.11. Troubleshooting

If you are experiencing problems when trying to connect to the device use the troubleshooter that assists you to help to find and resolve it.

10 Technical Specifications

10.1. Frequency bands and measurement range

Frequency range	50 MHz to 6.0 GHz continuous frequency coverage	
Frequency bands	Pre-defined or fully customizable lists of center frequencies (selectable in software)	
Measurement bandwidth	35, 75 and 100 MHz	
Dynamic range	> 60 dB raw dynamic range (0.02 – 20 V/m nominal range); Measurement range extension using <i>high sensitivity mode</i> (up to 6V/m) or <i>high field strength mode</i> (up to 50 V/m) using selectable built-in electronic attenuator.	
Sensitivity (6V/m range) RMS field strength	Measurement frequency	Typical lower detection limit
	80 – 250 MHz	< 0.01 V/m
	250 – 4500 MHz	< 0.005 V/m
	4500 – 6000 MHz	< 0.009 V/m
Spectrum analyzer mode	Wideband frequency scan over the full frequency range using 35 MHz BW filter	

10.2. Calibration Options

Base Version	- Calibration of 25 frequency bands (selected by customer) - Spectrum analyzer mode is available but only with coarse calibration.
Extended Calibration	- Calibration of 25 frequency bands (selected by customer) - Calibrated spectrum analyzer mode
Full calibration	- Calibration of 25 frequency bands (selected by customer) - Full measurement range of device is calibrated. Allows to perform calibrated measurements on any selectable frequency / bandwidth combination.
Upgrades	Device calibration options can be upgraded after purchase. The device must be sent in to make additional measurements at our calibration facility. No hardware modifications are required.

10.3. RF Measurement

Detection method	Simultaneous True-RMS and envelope peak field strength measurement within a 50-ms observation time for each frequency band
Sample interval	User-selectable; from 3 to 6000 seconds in steps of 1 second. The recommended minimum sample interval without samples being skipped depends on the number of active measurement bands: <ul style="list-style-type: none"> • 10 measured bands: 2 seconds • 25 measured bands: 4 seconds (GPS OFF) • 25 measured bands with GPS enabled: 5 seconds
Antenna	Tree axis isotropic antenna
Frequency crosstalk	-40 to -60 dB (typical)

10.4. Size / Conditions

Size and weight	16 cm x 8 cm x 3-5 cm (L x W x H) Weight: 360 g
Device Calibration	15 field levels, three axes (for each frequency band)

Conformity	Certified for CE (Europe), FCC (US), MIC (Japan), CB Ref. Certif. No. CH-11129 US: Contains FCC ID: 2ADHKATWINC1500 Japan: This equipment contains specified radio equipment that has been certified to the Technical Regulation Conformity Certification under the Radio Law. JRF Certificate number 005-101762
Operating Conditions	Temperature -5 to +50 Degrees Celsius; 0 to 90% rel. humidity, non-condensing; Intended for indoor use; Outdoor use possible with protective enclosure or bag (contact us for possible solutions).
Cleaning	To clean the instrument, use a damp cloth or mild, water-based cleaner. Clean the exterior of the instrument only. Do not apply cleaner directly to the instrument or allow liquids to enter or spill on the instrument.

10.5. Connectivity / Storage

Time	Integrated precision (± 2 ppm) real time clock
Connectivity	USB, Wi-Fi (2.4 GHz), GPS
Marker	Built-in marker button to highlight specific events
Data logger storage	Size and type: 16 GB, non-volatile flash memory. Capacity: >10 million (25 frequency bands per measurement) Max number of data sets: 500

10.6. Battery Management

Battery	Built-in rechargeable Li-ion battery. Battery replacements are possible within the device calibration service. It is not recommended to replace the battery without a device re-calibration.
Typical Operating time	Number of bands = 25, interval = 6 seconds GPS ON: > 18 h GPS OFF: > 38 h Number of bands = 25, interval = 60 seconds (1 min) GPS ON: > 40 h GPS OFF: > 120 h (5 days)
Charging	USB interface: USB compliant charger ports are supported (preferably 1A or more) Active measurements continue while charging.

10.7. ExpoM-RF Utility Software

Processor	Dual core processor recommended
Operating Systems	Windows (7, 8, 10, 11)
Storage usage	850 MB / 20 MB (Lightweight version)
Installation	No installation required – ExpoM RF Utility can be started directly. For the Lightweight installation the appropriate .NET version needs to be installed separately.
Download	See product page: www.fieldsatwork.ch/products/expom-rf/expom-rf4/

10.8. ExpoM-RF Android Software

Processor	64-bit CPU recommended
Operating System	Android 4.1 or newer
Storage usage	Less than 5 MB
Hardware requirements	Requires Wi-Fi Hotspot (i.e. SIM-card slot and/or configurable access point)
Download	See product page: https://fieldsatwork.ch/products/expom-rf/expom-rf4/